



# YN560-III

## USER MANUAL

Before use, please READ this user manual carefully in order to ensure your safety. Keep it properly for reference in the future.



## **I . Warning**

To avoid fire or electrical shock, do not expose this product to rain or moisture.

To avoid short circuit, be sure the batteries contacts are securely packed and in accordance with local provision when handling the batteries.

Please place the batteries and the parts which can be swallowed mistakenly away from children.

Contact a doctor immediately when it occurs.

To avoid possible injury to eyes, do not use the flash light in a short distance from the eyes.

To avoid possible safety accident, do not use the flash light on the people who need a high degree of attention.

Please take out the batteries and stop using immediately in case of below:

- This product is dropped or shocked seriously and the inner part of the product is bared.
- If the battery leaks corrosive liquids, please take out the battery with gloves.
- The product gives off strange smell, smokes or heats.

Do not disassemble or maintain this product. Touching the internal high voltage circuit will cause electric shock.

Remove batteries during long periods of non-use.

## II . Features

- **2.4G ULTRA-LONG-RANGE WIRELESS FLASH**

Support 2.4G ultra-long-range wireless flash, the farthest triggering distance is up to 100 meters.

- **FULLY SUPPORT RF-603, RF-602 WIRELESS TRANSMITTER**

The same YN560-III can receive the signals sent by RF-603, RF-602 wireless transmitters, supporting 16 channels, easy to realize wireless flash.

- **LARGE-SIZE LCD**

The YN560-III is equipped with large - size LCD screen, it is convenient for you to clearly and intuitively view or set all functions of the flash, convenient and fast to use.

- **PROVIDED WITH POWER ZOOM FUNCTION**

Lamp cover focal length can be altered within 24~105mm by pressing [ZOOM] button.

- **GN58 @ ISO100, 105mm**

High index 2.4G radio flash, support M/Multi mode

- **A VARIETY OF TRIGGER SYNCHRONIZATION, FLEXIBLE AND CHANGEABLE**

The YN560-III can be triggered through the camera set-top, 2.4G radio, S1 and S2 preflashing.

- **PROVIDES CHARGING SOCKET FOR EXTERNAL POWER PACK**

YN560-III provides charging socket for external power pack, to meet your higher demand for charging recycle.

- **PC PORT SUPPORTED**

YN560-III provides PC port, you can make the flash synchronously by connecting to the PC port.

- **SOUND PROMPTING SYSTEM**

When the sound prompting system is enabled, the different sound ways will prompt the different working conditions of the speedlite so as to make you focus on shooting only.

- **SUPER SPEED OF CHARGING RECYCLE**

It only takes 3 seconds in charging after full power output. Even without new batteries, you can get the super charging speed that it only needs 4~5 seconds; In addition, you can use the external power pack to accelerate the charging speed once more.

- **ADVANCED OPTION FUNCTIONS**

YN560-III has advanced options setting function, where you can self-define the functions of the speedlite on your own requirements.



- **THE AUTOMATIC SETTING SAVING**

YN560-III can automatically save your current setting.

- **METAL HOT-SHOE STAND**

### III. Quick Start

**If you don't have much time to read the whole user manual, we advise you to read this section.**

1. Please avoid the excessive use of the output with maximum power. It can effectively extend the service life of this product.
2. You can understand the function of each button by pressing them and observing the displayed content.
3. Press the [UP], [DOWN], [LEFT], and [RIGHT] buttons to adjust the parameters of speedlite quickly at the current mode. For some parameters, the [OK] button in the center is needed to be pressed for setting.
4. Press [  ] button to select camera set-up flash mode, S1/S2 slave flash mode or RX slave flash mode.
5. Using RX slave mode, set channels by [ZOOM] and [Triggering Mode] buttons.
6. Select the function of advanced option through [  ] and [MODE] buttons. See the section of “Advanced Setting” for the content.
7. Select <rF 603> item through “Advanced Setting”, then you can adjust it to <rF 602> by pressing [LEFT][RIGHT] button, which compatible for RF-602 transmitter.
8. This product provides M, Multi mode, select the modes by pressing [MODE] button.

## IV. Nomenclature

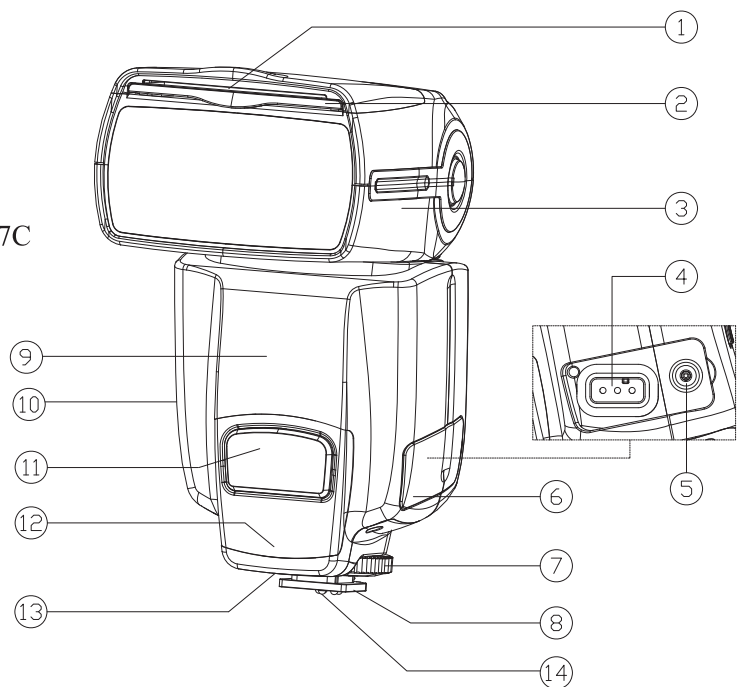

1. Reflection board
2. Wide-angle diffuser
3. Flash light's head
4. External power pack socket  
(It can be connected to the SF-18C or SF-17C external power pack)
5. PC port (for input)
6. Contact cover
7. Locking ring
8. Hot shoe stand
9. 2.4G wireless receiving module
10. Battery chamber's cover
11. Optical control sensor
12. Slave mode indicator
13. Sound port
14. Hot shoe pin

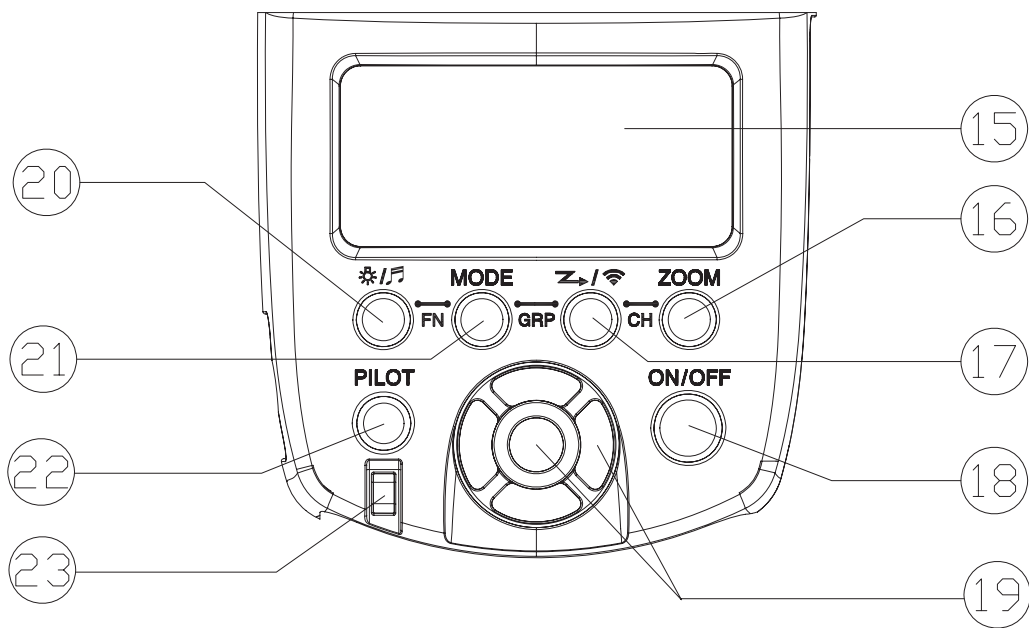



**15. LCD panel:** It will display the status of function settings.

**16. ZOOM button:** Directly operating [ZOOM] button can adjust the zoom rang of lamp holder (24, 28, 35, 50, 70, 80, 105mm).

**17. Triggering Mode button (  /  ):** The flash triggering mode shall switch among camera set-up, S1, S2, RX with every pressing.

**18. Power switch (ON/OFF):** Press this button for about 2 seconds and turn on or off the power of speedlite.

**19. Select/set button group:** Buttons of multi functions include LEFT, RIGHT, UP, DOWN and OK buttons; with these buttons, you can adjust output, Stroboscopic flash count, Stroboscopic flash frequency, advanced options parameter, wireless channels and so on.

**20. Illumination /sound switch:** LED backlight can be turned on or off by pressing this button for a short time; and sound prompt function of the speedlite shall be turned on or off by pressing this button for about 2 seconds.

**21. Mode switch button (MODE):** The mode of speedlite will be switched between M/Multi mode.

**22. Charging indicator/Test button (PILOT):** Red lamp means charge is completed, flash can be made; green lamp means charge is being on, and press this button (PILOT), the speedlite shall send test flash.

**23. Signal indicator:** The signal indicator will lit up in blue, while speedlite receive radio signal from RF-602 or RF-603, the signal indicator will lit up in red, while speedlite is triggered.



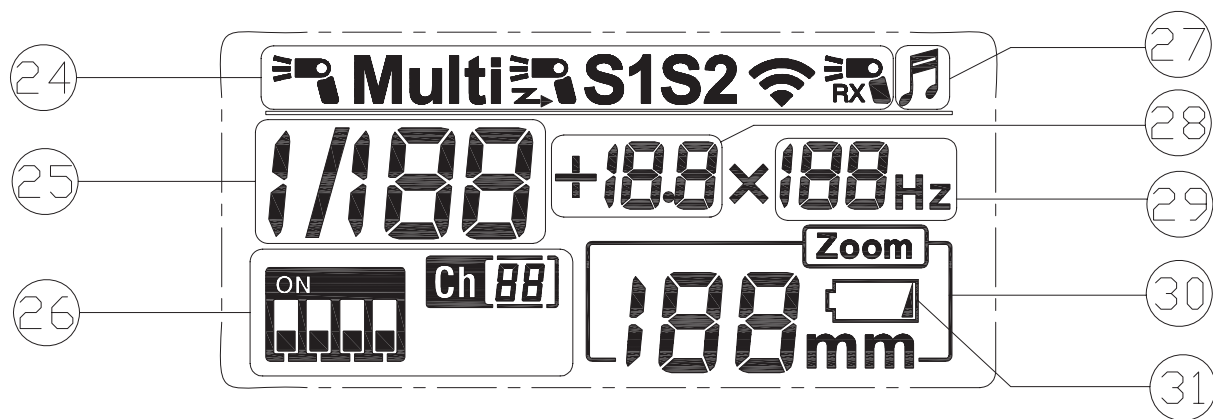

24. Flash mode/Triggering mode indicator

25. Output level indicator

26. Channel indicator

27. Sound prompt

28. Stroboscopic flash count indicator/Output level fine

29. Flash frequency indicator

30. Flash head zooming indicator

31. Power low indicator

## V. Installation Instruction

### 1. Install Batteries

Slide the batteries chamber's cover in the direction of the arrow.

Insert the batteries according to the label inside battery chamber.

Make sure the direction of the batteries' polarity is correct.

Close the battery chamber cover in the direction of the arrow.

### 2. Mount the speedlite on your camera

Loosen the locking ring by turning it in the direction of the arrow.

Slip the speedlite hot shoe stand into the camera hot shoe stand until it stops.

Turn the locking ring in the direction of the arrow tighten.

To detach the speedlite, loosen the locking ring by turning it in the opposite direction.

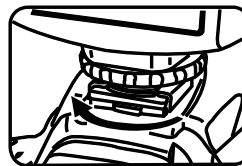
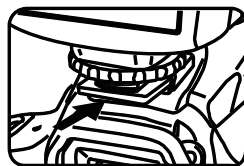
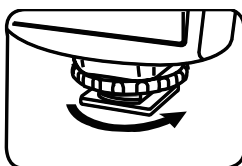
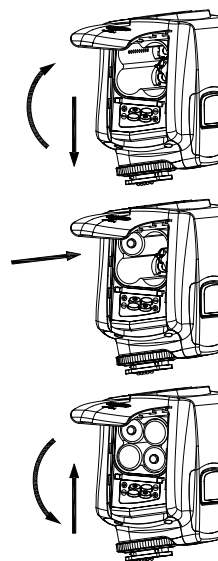

## VI. Basic Functions

### 1. Basic Operations

Operation of the buttons:

Component	Operation
[Power Switch]	The power of the speedlite can be turned on or turned off by holding this button for 2 seconds. It is suggested that the batteries shall be taken out after the power of the speedlite is turned off through this button.
[Mode Switch] button	The mode of the speedlite will be switched among the M/Multi in circle for each press.
[Triggering Mode] button	The flash triggering mode shall switch among camera set-up, S1, S2, RX with every pressing.
[Illumination/sound] button	LCD backlight can be turned on or off by pressing this button for a short time; and sound prompt function of the speedlite shall be turned on or off by pressing this button for about 2 seconds.
Selection/setting button set	Buttons of multi functions include LEFT, RIGHT, UP, DOWN and OK buttons; with these buttons, you can adjust output level, Stroboscopic flash count, Stroboscopic flash frequency, advanced options parameter, wireless channels and so on.
ZOOM button	Directly operating [ZOOM] button can adjust the zoom rang of lamp holder (24, 28, 35, 50, 70, 80, 105mm).
[PILOT] button	Red lamp means charge is completed, flash can be made; green lamp means charge is being on, and press this button (PILOT), the speedlite shall send test flash.

### Meaning of [Charging indicator]

Status of [Charging Indicator]	Meaning	Operation
The red light is lit	The speedlite is fully charged, and can be used.	Normal
The green light is lit	The speedlite has not been fully charged or power low	If the green light is lit for a long time, please replace the batteries.
The red light blink	The speedlite is in the sleeping state.	Press [PILOT] or [ON/OFF] button to wake up.

### The meaning of [Sound Prompt]

The sound form	Meaning	Operation
Tick twice	The speedlite is started / Sound prompt is enabled/flash is obtained.	Normal
Tick three times	The speedlite is in the charging state	Waiting for the completion of charging
Continuous and quick ticks	The power is not enough, speedlite will be off.	Please replace the batteries.
Tick—a long sound	The speedlite is fully charged, and can be used.	Normal

## **2. Power-on and Power-off**

The power of the speedlite can be turned on or turned off by holding this button for 2 seconds. It is suggested that the battery shall be taken out after the power of the flash light is closed through this button.

Turn on the power of the speedlite, the charging indicator is red, which indicates the flash is available.

If the charging is not completed within about 25 seconds, the flash will automatically shutdown. Then you need to replace with new batteries.

You may press the testing button PILOT to test whether the speedlite works normally.

After use, hold the power switch for 2 seconds to power off.

## **3. M Mode**

In M mode, you can set the flash output level as you like. By [LEFT] [RIGHT], [UP] [DOWN] and [OK] in the middle, you can adjust the flash output level. The adjustment range of the flash output level is  $1/128 \sim 1/1$ . There are 8 levels of output and each level has 4 fine tuning stalls. The [UP] [DOWN] is used to fine tune the output power in 0.3ev and 0.5ev. For shooting, what you need is to set the flash output level, adjust the camera and press the shutter. The flash will flash with the synchronic signal of the camera.

## **4. Multi Mode**

With MULTI mode, a rapid series of flashes is fired. It can be used to capture multiple images of a moving subject in single photograph.

The speedlite will flash according to the output power, flash times and frequency you set. Use [LEFT], [RIGHT]

and [OK] buttons to adjust output power, flash times and frequency. The adjustment scope of output level is 1/128-1/64-1/32-1/16-1/8-1/4, you can adjust the output level by [LEFT] [RIGHT] directly. The scope of flash times is from 1 to 100, and the scope of flash frequency is from 1 to 100. Adjustment method: please press [OK] button to select setting items (flash) and use the [LEFT] [RIGHT] buttons to adjust the parameters. After the setting is completed, press [OK] button to confirm the setting.

The charging speed of speedlite is slow under the situation that the electricity quantity of the battery is insufficient, which may cause the occurrence of the high-frequency flash. Please reduce the flash frequency or change new battery under this situation.

## **5. RX slave mode**

RX slave flash mode can be selected though pressing down button [Triggering Mode]. The slave flash mode is transmitted by 2.4G radio, respectively supporting YONGNUO wireless trigger RF-602, RF-603. Choose to support the RF-602 or RF-603 triggering through the Advanced Options settings, provided with 16 channels (CH1~CH16). Just set the YN560-III and RF-602, RF-603 to the same channel wireless flash can be realized in using. RX slave flash mode is similar to the top, M/Multi modes can be set respectively when operating button [MODE], when set as - -, it indicates that the flash of RX slave flash mode is prohibited.

## **6. S1/S2 Modes**

By pressing the [Triggering Mode] button, the flash will step into the S1/S2 mode. These two modes are suitable to be used as off-camera auxiliary light, so as to create a variety of lighting effects. They are suitable for manual flash environment and TTL flash environment respectively. Under these two modes, the way to adjust the output level is like that in M mode, which is to press the [LEFT] [RIGHT], [UP] [DOWN] button. When using S1/S2 mode, you can rotate the flash head to make the wireless triggering sensor face with the master light.

When the flash is in S1 mode, it will work with the first work of the master flash synchronously, with the result consistent with the use of radio slave. To use this mode correctly, the master flash should be set at manual flash and the TTL flash system with preflight function and the red-reduction function with multiple flashes should not be used.

S2 mode: It is also called “pre-flash cancel mode”. This mode is similar with S1 mode, but it can neglect the pre-flash given by TTL flash. Therefore, it can support the main flash working in TTL mode. In particular, if S1 mode cannot flash correctly and synchronically with your internal flash, you can try to use S2 mode.

The following situation shall be avoided when the S1 and S2 modes are used: the red eye reduction function of the main light is used; the order mode (Nikon) or wireless mode (Canon) of the master is used; the ST-E2 is used as the flash controller.

## **7. Test Flash**

Whether in any mode, you can press PILOT button to test if the speedlite flashes normally.

When testing the speedlite, the speedlite will give flash at relevant output level in accordance with the chosen output power setting.

### 8. Power saving mode

In different flash modes, YN560-III will perform a variety of power-saving mode. For example, < SE oF 3 30> denotes flash -top use, it will go to sleep mode after idling for 3min, and turns off automatically after idling for 30min.

The YN560-III has three different power saving modes, including top flash power saving mode, S1/S2 flash power saving mode, RX radio flash power saving mode. Various power-saving modes can be set through the Advanced Options. Methods to set up: operate [Illumination/Sound] +[ MODE] to enter the Advanced Options setting status, select the item to be set through buttons [Up], [Down], and then adjust the parameter through [Left], [Right].

Power saving modes can be set through Advanced Options are as follows:

Fn Options	Scope of Application	Power saving mode
SL EP on/--	All modes	Power saving mode is turned on or off
SE oF 3 30/15 60/30 120/ -- 120	Camera set-up	3 30/15 60/30 120: Keeping idle for 3/15/30 minutes will enter the dormancy state and 30/60/120 minutes will shut down the speedlite. -- 120: No dormancy, Shut down after keeping idle for 120 minutes.
Sd 30/60/120	S1/S2 slave flash modes	30/60/120: No dormancy, Shut down after keeping idle for 30/60/120 minutes.



Sd 5 30/15 60/30 120/ -- 120	RX slave flash modes	5 30/15 60/30 120: Keeping idle for 5/15/30 minutes will enter the dormancy state and 30/60/120 minutes will shut down the speedlite. -- 120: No dormancy, Shut down after keeping idle for 120 minutes.
---------------------------------	----------------------	---

### 9. Overheating protection

If the speedlite is used too frequently, its overheating protection function will be triggered, and the speed of charging will be slower as normal. In such case, please wait for about 3 to 5 minutes to cancel the protection. Please try to use the 1/4 output or lower when rapid shooting is needed to prevent the effect on the shooting.

### 10. Manually set the zooming position

By pressing [ZOOM ] button, you can manually set the zooming position. And the covered focal length of the speedlite will switch in circle of (24 / 28 / 35 / 50 / 70 / 80 / 105mm), the zoom setting results will be displayed on the LCD screen.

### 11. Sound prompt

Under the condition that the sound indicator is enabled, the speedlite will give different sounds to indicate its working situations. The meanings of the sounds can be found in the table below:

The sound form	Meaning	Operation
Tick twice	The speedlite is started / Sound prompt is enabled/Flash is obtained.	Normal
Tick three times	The flash is in the charging state	Waiting for the completion of charging

Continuous and quick ticks	The power is not enough, speedlite will be off	Please replace the batteries.
Tick—a long sound	The speedlite is fully charged, and can be used.	Normal

### 12. PC synchronous port (for input)

By connecting to the PC synchronous port, you can make the flash synchronously.

### 13. Automatic setting saving

The speedlite will automatically save the current settings in order to let you have a simpler use next time after boot.

## VII. The Advanced Application

### 1. Multi-flash Lighting Application

The YN560-III is provided with not only S1/S2 slave flash mode but also RX slave flash mode, compatible better to YONGNUO RF-602, RF-603 triggers. When using S1/S2 slave flash mode, built-in flash or the top external flash shall be used as the main flash; when using RX slave flash mode, directly use RF-602, RF-603 triggers to trigger, Just set compatible [RF-602] or [RF-603 ] triggering method in the flash Advanced Options settings of YN560-III, and set flash and RF-602, RF-603 transmitting terminal as the same channel, then triggering flash can be conducted.

S1/S2 slave flash mode can meet your basic lighting demand, when using S1/ S2 do not place obstructions between the main flash and slave flash, or obstructions would hinder the transmission of a wireless signal. Wireless photosensitive trigger flash has an indoor use maximum distance of up to 25 meters and outdoor use maximum distance up to 15 meters.

Using RX slave flash mode, effectively reduce the impact of obstructions on the radio signal, at the same time, you can get farther triggering distance, and maximum distance is up to 100 meters.

You can choose slave flash mode suitable for your current state according to your need.

## 2. The use of external charging box

You can buy YONGNUO external charging boxes like SF-18C or SF-17C and connect it to the charging port of the flash. After flash, the charging box will charge the speedlite.

## 3. High-speed continuous shooting

The flash can realize the high-speed continuous shooting function. Please set the camera in the continuous shooting form and then shoot.

Please note: The number of photos that can be continuous shot is related with the output level. Please use the fully charged battery.

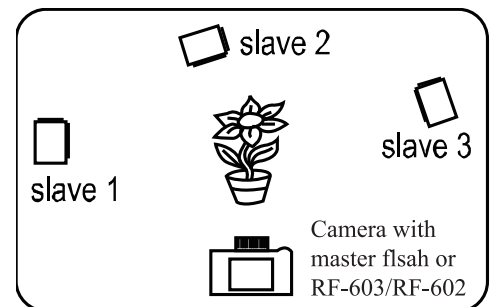

#### 4. Rear-curtain Sync

You can use slow-speed shutter to produce trailing smear for the object and the flash light will flash at the moment when the shutter is going to be shut, which means the rear-curtain sync function(The rear-curtain sync function needs the camera's own support and you can refer to the camera's user manual for its setting method).

#### 5. Advanced Options Setting

YN560-III has advanced options function, you can customize speedlite function as you need, set advanced options with button group of the speedlite. Setting method of the buttons of the speedlite: Press [Illumination/Sound] and [MODE] button to enter into the setting state of advanced options function, select setting items by pressing [UP][DOWN] button, adjust parameters of each item by pressing [LEFT][RIGHT], and the LCD screen shall show set items; such as: <SE oF 3 30> means the application at the roof, the speedlite shall automatically sleep if it is idle for 3 minutes, and automatically power off if it is idle for another 3 minutes.

Advanced options function supported by YN560-III is as following:

SL EP on: Auto power off is enabled

SL EP --: Auto power off is disabled



SE oF 3 30/15 60/30 120: Keeping idle for 3/15/30 minutes will enter the dormancy state and 30/60/120 minutes will shut down the speedlite.

SE oF - - 120: No dormancy, Shut down after keeping idle for 120 minutes.

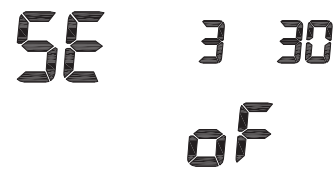

SE 3 30  
oF

Sd 30/60/120 : S1/S2, Slave auto power off cancel within 30/60/120 min



Sd 60

Sd 5 30/15 60/30 120: RX wireless flash, keeping idle for 5/15/30 minutes will enter the dormancy state and 30/60/120 minutes will shut down the speedlite.

Sd - - 120: No dormancy, Shut down after keeping idle for 120 minutes.



Sd 5 30

Lcd 7/15/30: The display time of LCD backlight is 7/15/30 seconds



lcd 7

So nd on: Sound prompt function is enabled

So nd - - : Sound prompt function is disabled



So nd on

I nc 0.3: 0.3ev for fine-tuning step

I nc 0.5: 0.5ev for fine-tuning step

I nc 0.3 5: Mix 0.3ev and 0.5ev for fine-tuning step



Inc 0.3 5

qu ic - - : Quick turn on / shut down function is disabled  
qu ic on: Quick turn on / shut down function is enabled

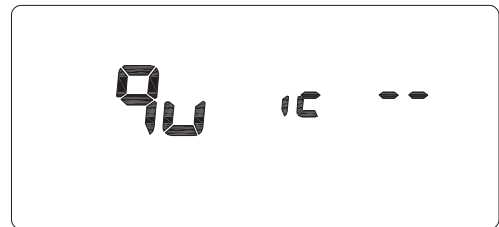

rF 603: Compatible for RF-603 transmitter  
rF 602: Compatible for RF-602 transmitter

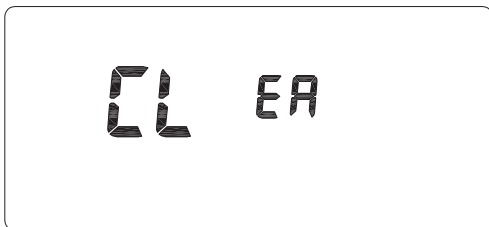
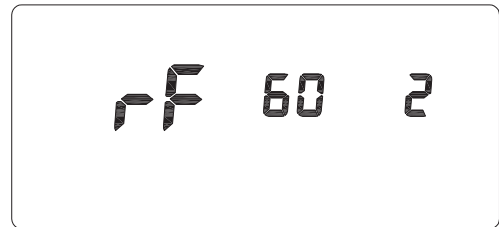

CL EA - -: Recover the default settings (**Hold the [OK] button to recover the default settings**)

## 6. Reflection Flash

Bounce flash means to take photos by making flash light head aimed at wall or ceiling and using the light reflected back from the ceiling or wall to light the desired object, so that the shade behind the object can be decreased to get more natural shooting effect.

If the wall or ceiling is too far, the bounce flash may be too weak to get enough exposure. The wall or ceiling should be even and white in order to get efficient reflection; if the reflection surface is not white, color cast may appear in photo.

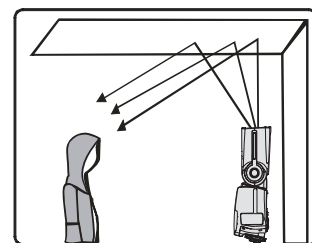

## 7. Use Reflection Board to Take Photos

With the reflection board flash, draw the reflection board and the wide-angle diffusion board out from the light head at the same time and then push the wide-angle diffusion board back. In such case, if this product is being used to take photos, it will produce a highlighted point on the eyes of the subject and thus make the eyes charming (catch light). This function can reach optimal effect when the flasher head is up 90°.

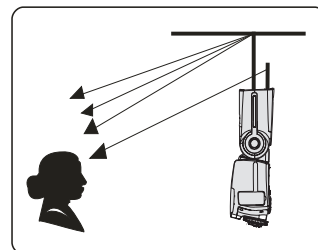

## 8. Use Wide-angle Diffuser

Pull out the wide-angle diffusion board, push back the reflection board and arrange them as per the figure; in such case, the flash scopes will extent to 18 mm and the flash effect will be softer and more natural.

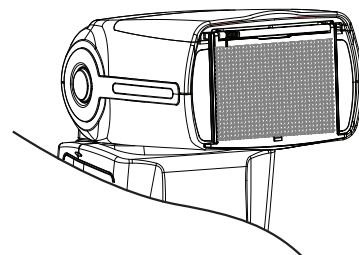



## VIII. Specifications

Circuit design	Insulated Gate Bipolar Transistor (IGBT)
Guide No.	58 (ISO 100, 105mm)
Flash mode	M, Multi
Triggering mode	Camera set-up, S1, S2, RX
Zoom range	24, 28, 35, 50, 70, 80, 105mm
Vertical rotation angle	-7~90 degrees
Horizontal rotation angle	0~270 degrees
Power supply	4×AAsize batteries (Alkaline or Ni-MH are usable)
Lighting times	100~1500 times (AA alkaline cell used)
Recycle time	approx 3s (AA alkaline cell used)
Color temperature	5600k
Flash time	1/200s~1/20000s
Flash control	8 levels of output control (1/128~1/1), 29 levels of fine tuning
External interface	hot shoe, PC port and external charging port
Wireless triggering distance	100m (2.4G wireless); 20~25m indoor, 10~15m outdoor (Optical control)
Additional features	The electronic flash head zooming, sound prompt, automatically saving setting, power saving mode, overheating protection and Advanced Options.
Dimensions	60×190×78mm (Extended state)
Net weight	350g
Accessories	Flash light (1), protecting bag (1), mini stand (1) and manual (1)

Guide Number of different focal length range (at ISO 100, in meters / feet)

Flash Output	Flash Coverage (mm)							
	14	24	28	35	50	70	80	105
1/1	15/49.2	28/91.9	30/98.4	39/127.9	42/137.8	50/164	53/173.9	58/190.3
1/2	10.6/34.8	19.8/65	21.2/69.6	27.6/90.7	29.7/97.4	35.4/116.1	37.5/123	41/134.5
1/4	7.5/24.6	14/45.9	15/49.2	19.5/64	21/68.9	25/82	26.5/86.9	29/95.1
1/8	5.3/17.4	9.9/32.5	10.6/34.8	13.7/45.2	14.8/48.6	17.7/58.1	18.7/61.4	20.5/67.3
1/16	3.8/12.5	7/23	7.5/24.6	9.7/32	10.5/34.4	12.5/41	13.3/43.6	14.5/47.6
1/32	2.7/8.9	4.9/16.1	5.3/17.4	6.9/22.7	7.4/24.3	8.8/28.9	9.4/30.8	10.3/33.8
1/64	1.9/6.2	3.5/11.5	3.8/12.5	4.9/16	5.3/17.4	6.3/20.7	6.6/21.7	7.3/24
1/128	1.3/4.3	2.5/8.2	2.7/8.9	3.5/11.4	3.7/12.1	4.4/14.4	4.7/15.4	5.1/16.7

## IX. Possible problems during use and solutions

**1. Please note when use the flash outdoors:** For outdoor application, please avoid direct sunlight to the wireless triggering sensor and ensure normal use of the flash.

**2. Precaution for outdoor use of lambency umbrella:** The lambency umbrella mounted on the flash light outdoors may be blown down easily, and the hot shoe of the flash light may be broken. Please fix the mounting rack or avoid outdoor use.

**3. Photos are under exposure or over exposure?** Check if the set shutter, aperture and ISO are too near the flash limit or if some settings in relation to flash are proper.

**4. Vignetting appears in photos or only part of the subject is illuminated?** Please check the current coverage of focal length and make sure if the lens focal length exceeds the coverage range of the flash. The product's zooming range is 24~105mm of the medium format system. You can try to pull out the wide-angle diffuser to expand the flash range.

**5. The flash light is abnormal?** Switch off the power of flash light and camera, mount the flash light on the hot shoe of camera, and switch on the power of flash light and camera again. If the abnormality continues, replace the batteries.

The functions of this manual are based on test conditions of our company. Further notice will not be given if the design and specifications change.

The YONGNUO logo in this manual includes the registered trademark or trademark of **SHENZHEN YONGNUO PHOTOGRAPHY EQUIPMENT Co., Ltd** in China or/and other countries (regions). All other trademarks are the property of their respective owners.